



Acclaim & Zodiac Acclaim

DECORATIVE FUEL EFFECT GAS FIRES

**THIS PRODUCT IS NOT SUITABLE FOR
PRIMARY HEATING PURPOSES**

Installation, Maintenance & User Instructions

Hand these instructions to the user

Model No's NITCMN3, NITC**RN3, NRDC**MN3, NRDC**EN3 & NRDC**RN3 are for use on Natural Gas (G20) at a supply pressure of 20 mbar in G.B. / I.E.**

Model No. NITCMP3 & NRDC**MP3 is for use on Propane Gas (G31) at a supply pressure of 37 mbar in G.B. / I.E.**

**** denotes cosmetic variance**

CONTENTS

Section 1	Information and Requirements	PAGE
1.0	Appliance Information	3
1.1	Conditions of Installation	4
1.2	Flue and chimney suitability	4
1.3	Fireplace / surround suitability	5
1.4	Shelf position	5
1.5	Chimney inspection	5
1.6	Fire place opening / catchment space	6-7
1.7	Fitting to chair bricks	8
1.8	Metal flue boxes	8
1.9	Hearths	8
1.10	Spillage monitoring system	8
Section 2	Installation of Fire	
2.1	Unpacking the fire	9
2.2	Installing the fire box	9-12
2.3	Gas tightness and inlet pressure (MC models)	13
2.4	Gas tightness and inlet pressure (RC models)	13
Section 3	Assembling Fuel Bed and Commissioning	
3.1	Assembling the ceramics and fuel bed	14-17
3.2	Fixing the position of the infra-red eye	18
3.3	Connecting the battery pack	19
3.4	Fitting the trim (Zodiac Acclaim models only)	19
3.5	Fitting the fret (Acclaim & Zodiac Acclaim models)	19
3.6	Lighting the appliance (MC models)	20
3.7	Lighting the appliance (RC models)	21
3.8	Lighting the appliance (EFC models)	22
3.9	Checking for clearance of combustion products (Acclaim & Zodiac Acclaim models)	23
Section 4	Maintenance	
4.1	Removal of the burner assembly (MC models)	24
4.2	Removal of the piezo igniter (MC models)	24
4.3	Removal of the control tap (MC models)	25
4.4	Removal of the oxypilot (MC models)	25
4.5	Removal of the burner assembly (RC / EFC models)	26
4.6	Removal of the valve assembly (RC / EFC models)	26
4.7	Removal of the pilot assembly (RC / EFC models)	27
4.8	Removal / replacing the batteries (RC / EFC models)	27
4.9	Removal of the trim switch (EFC models)	27
Section 5	User Instructions Section	
5.1	Conditions of Installation / about your new gas fire	28
5.2	Operating the fire (MC models)	29
5.3	Operating the fire (RC models)	30-31
5.4	Operating the fire (EFC models)	31-32
5.5	Turning the RC / EFC models off if the handset / trim sw is not working	33
5.6	Replacing the batteries (RC / EFC models)	33
5.7	Cleaning the fire	34
5.8	Replacing the fuel-bed and ceramics	35-38

This appliance is manufactured by :-
BFM Europe Ltd, Trentham Lakes, Stoke-on-Trent, ST4 4TJ

SECTION 1 INFORMATION AND REQUIREMENTS

1.0 APPLIANCE INFORMATION

Model	NITC**M/RN3 NRDC**M/E/RN3	NITC**MP3 NRDC**MP3
Gas Type	G20	G31
Main injector (1 off Cat 82)	Size 420	Size 190
Pilot Type	Manual Control	Manual Control
	Copreci 21100 / 141 Copreci 21100 / 166	
	Remote & Easy Flame Control	
	Copreci 21100 / 162	
Maximum Gross Heat Input :	6.9 kW	6.9 kW
Minimum Gross Heat Input :	4.2 kW	5.2 kW
Cold Pressure :	20.0 +/- 1.0 mbar	37.0 +/- 1.0 mbar
Ignition :	Push-button piezo (manual control) 9V electronic (remote and easy flame control)	
Electrode Spark Gap	4.0mm	
Packed Weight	7kg (Acclaim tray only) 20kg (Zodiac Acclaim tray & hotbox)	

Acclaim Inset Tray Dimensions (with ceramic & coals fitted)

Width :	380mm
Height :	320mm
Depth :	230mm

Zodiac Acclaim Firebox Dimensions

Width :	400mm
Height :	555mm
Depth :	235mm

Gas Connection : 8mm Compression (Supplied with fire)

INSTALLATION REQUIREMENTS

1.1 CONDITIONS OF INSTALLATION

It is the law that all gas appliances are installed only by a GAS SAFE Registered Installer, in accordance with these installation instructions and the Gas Safety (Installation and Use) Regulations 1998 as amended. Failure to install appliances correctly could lead to prosecution. It is in your own interest and that of safety to comply with the law.

The installation must also be in accordance with all relevant parts of the Local and National Building Regulations where appropriate, the Building Regulations (Scotland Consolidation) issued by the Scottish Development Department, and all applicable requirements of the following British Standard Code of Practice.

1. B.S. 5871 Part 1 & 3 Installation of Decorative Fuel Effect / Inset Gas Fires
2. B.S. 6891 Installation of Gas Pipework
3. B.S. 5440 Parts 1 & 2 Installation of Flues and Ventilation
4. B.S. 1251 Open fire place components
5. B.S. 715 Metal flue pipes for gas appliances
6. B.S. 6461 Part 1 Installation of Chimneys and flues
7. I.S. 813 : 1996 Domestic Gas Installation (Republic of Ireland)

No purpose made additional ventilation is normally required for this appliance, when installed in G.B. When Installing in I.E. please consult document I.S. 813 : 1996 Domestic Gas Installation, which is issued by the National Standards Authority of Ireland. If installing in Northern Ireland, please consult local building regulations. Any purpose made ventilation must be checked periodically to ensure that it is free from obstruction.

1.2 FLUE AND CHIMNEY SUITABILITY

This appliance is designed for use with conventional brick built or lined chimneys and fabricated flues of 125mm diameter minimum. Any metal flue boxes used must conform to BS 715. All flues must conform to the following minimum dimensions.

Minimum diameter of circular flues (Class 1)	175 mm
Minimum diameter of circular flues (Class 2)	125 mm

Minimum effective height of Class 1 flue types	3 metres
Minimum effective height of Class 2 flue types	4 metres

Safe clearance of products must always be checked by carrying out a smoke match test as described.

1.3 FIREPLACE / SURROUND SUITABILITY

The fire must only be installed on a hearth it **must not be installed directly onto carpet or other combustible floor materials.**

The fire is suitable for fitting to non-combustible fire place surrounds and proprietary fire place surrounds with a temperature rating of at least 150°C.

If a heating appliance is fitted directly against a wall without the use of a fire surround or fire place all combustible material must be removed from behind the trim. Soft wall coverings such as blown vinyl, wall paper etc. could be affected by the rising hot air and scorching and/or discoloration may result. Due consideration should be made to this when installing or decorating.

1.4 SHELF POSITION

The fire may be fitted below a combustible shelf providing there is a minimum distance of 200mm above the top of the fire and the shelf does not project more than 150mm. If the shelf overhangs more than 150mm the distance between the fire and the shelf must be increased by 15mm for every 25mm of additional overhang over 150mm.

1.5 FLUE / CHIMNEY INSPECTION

Before commencing installation, a flue or chimney should be inspected to ensure that all the following conditions are satisfied.

1. Check that the chimney / flue only serves one fire place and is clear of any obstruction. Any dampers or register plates, other than those supplied on the cast front must be removed or locked in the open position.
2. Brick/stone built chimneys or any chimney or flue which has been used for an appliance burning fuel other than gas must be thoroughly swept. The base of the chimney / flue must also be thoroughly cleared of debris etc.
3. Any under-floor air supply to the fire place must be completely sealed off.
4. Ensure that the inside of the chimney / flue is in good condition along its length and check that there is no leakage of smoke through the structure of the chimney during and after the smoke pellet test.
5. **Using a smoke pellet, check that there is an up-draught in the chimney / flue and that the smoke can be seen issuing from the terminal / chimney pot outside. There must be no leakage of smoke through the structure of the chimney during or after the smoke pellet test and it is important to check inside upstairs rooms adjacent to the chimney / flue.**

Check the chimney pot / terminal and general condition of the brickwork or masonry. If the chimney or flue is in poor condition or if there is no up-draught do not proceed with the installation. If there is a history of down-draught conditions with the chimney / flue, a tested and certificated flue terminal or cowl suitable for the relevant flue type should be considered.

6. **A spillage test must always be carried out during commissioning of the appliance.**

1.6 FIRE PLACE OPENING AND CHIMNEY CATCHMENT SPACE

The front opening of the fire place must be between 405 and 425 mm wide, and between 550 and 570mm high. If the opening exceeds these dimensions then a surround must be constructed from suitable non-combustible material to produce a correct size opening. Any surround must be suitably sealed to the fire place to prevent leakage. See below in figure 1.

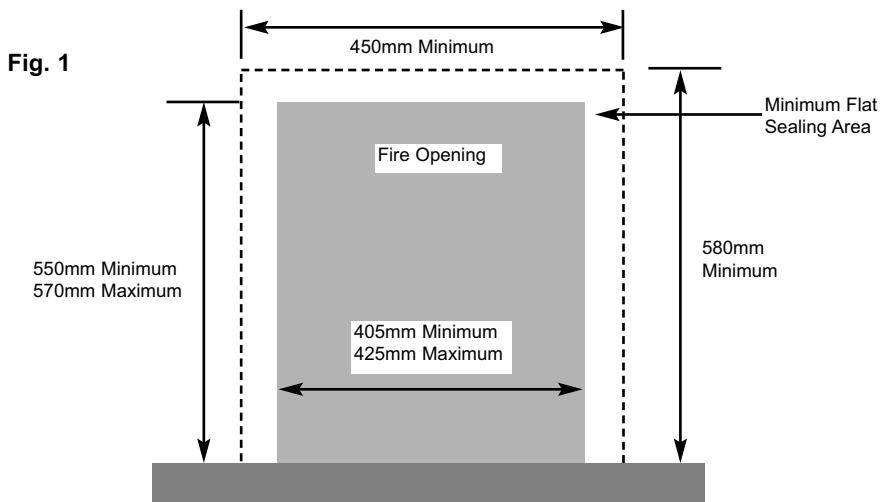

When installing into a brick built chimney, you must ensure that there is sufficient depth to accommodate any debris which may fall from the chimney. This depth must be sufficient to accommodate 12 litres of volumetric space.

Table A - Installation Depth Requirements for a Verine Zodiac Acclaim being installed requiring 12.0 litres of debris collection volume (fig. 2).

Opening Width (mm)	Minimum Depth Required (mm)
405	285

See fig. 2 below for explanatory diagram.

Fig. 2

The fireplace opening depth can exceed 285mm, providing that when calculated, the void volume does not exceed 247 dm³

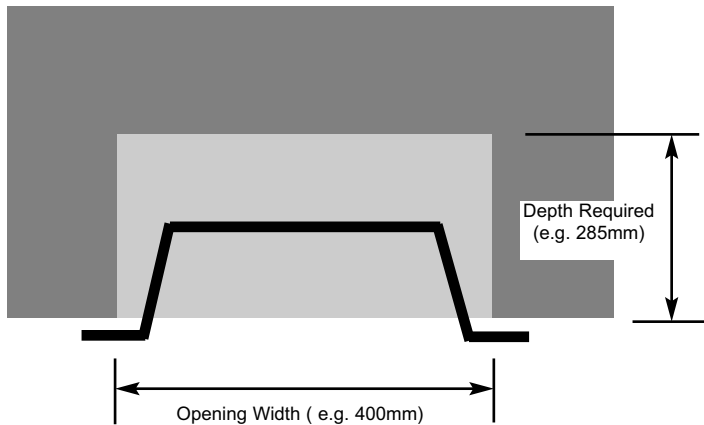

1.7 FITTING TO FIREPLACES WITH EXISTING CHAIRBRICKS AND CONVENTIONAL BRICKBUILT CHIMNEYS

The Acclaim Inset Tray is suitable for use in fireplaces fitted with an existing chairbrick, for the Zodiac Acclaim model any chairbrick must be removed prior to proceeding with the installation.

1.8 FITTING TO PRE-FABRICATED TWIN WALL METAL FLUE BOXES

The Zodiac Acclaim model may be fitted to twin wall metal flue boxes conforming to the constructional requirements of BS 715. The box must have a minimum flue diameter of 125mm internal and minimum internal dimensions of 300mm deep by 550mm high by 425mm wide. There are no maximum dimensional requirements for the box. The top face of the box must be insulated with a minimum thickness of 50mm of non-combustible mineral wool insulation or similar material. The flue box must stand on a non-combustible base of minimum thickness 12mm.

Note : If fitting this product with a 175mm diameter flue liner, 3 metres minimum effective flue height is required, if fitting with a 125mm diameter flue liner, 4 metres minimum effective flue height is required. **If the product is fitted to a pre-fabricated flue system of either 175mm or 125mm then the debris deflector plate fitted to the top of the Zodiac Acclaim product can be removed (held in place by 2 screws).**

1.9 HEARTH

This appliance must only be installed on to a concrete or non-combustible hearth. The hearth material must be a minimum thickness of 12mm with the top surface at least 50mm above the floor. The hearth must be fitted symmetrically about the fire opening and have a minimum width of 760mm and a minimum projection of 300mm forwards from the fire opening. EFC models required an increased hearth projection of 320mm forwards of the fireplace opening.

1.10 SPILLAGE MONITORING SYSTEM

This appliance is fitted with an atmosphere sensing spillage monitoring system in the form of an oxygen sensing pilot. This is designed to shut the fire off in the event of a partial or complete blockage of the flue causing a build up of combustion products in the room in which the fire is operated. **The following are important warnings relating to this spillage monitoring system :-**

- 1) The spillage monitoring system must not be adjusted by the installer.
- 2) The spillage monitoring system must not be put out of operation.
- 3) When the spillage monitoring system is exchanged only a complete original manufacturers part may be fitted.

SECTION 2 INSTALLATION OF FIRE

2.1 UNPACKING THE FIRE

Carefully lift the fire out of the carton. Remove the loose item packaging carefully from the front of the appliance. Check the contents as listed :-

Packing Check List - Acclaim Tray Models

- 1 off Fire tray / burner assembly
- 1 off Boxed ceramic base, L/H & R/H ceramic front rails plus coals
- 1 off Coals bag, containing, 3 medium square coals, 2 small square, 11 small coals & 7 large coals - total of 23 coals packed in ceramics box
- 1 off Loose items bag including fixing screws and rawlplugs
- 1 off Installation / user book (combined)

Packing Check List - Zodiac Acclaim Tray / Hotbox Models

- 1 off Fire tray / burner assembly & ceramic fibre lined hotbox.
- 1 off Boxed ceramic base, L/H & R/H ceramic front rails plus coals
- 1 off Coals bag, containing, 3 medium square coals, 2 small square, 11 small coals & 7 large coals - total of 23 coals packed in ceramics box
- 1 off Loose items bag including cable fixing kit
- 1 off Installation / user book (combined)

2.2 INSTALLING THE ACCLAIM TRAY

Establish which type of flue you are intending to install the fire in to :-

225 x 225mm (9 inch x 9 inch) brick built chimneys

175mm (7 inch) diameter lined brick or stone flue, or insulated pre-fabricated metal flue box to B.S. 715. (minimum effective flue height 3 metres)

125mm (5 inch) diameter brick or stone flue, or insulated pre-fabricated metal flue box to B.S. 715. (minimum effective flue height 4 metres)

A spillage test must always be carried out to check satisfactory clearance of flue products, regardless of the type of flue the appliance is being fitted to.

To Install an Acclaim tray proceed as follows :-

- a) Carefully place the burner tray in the chairbrick opening
- b) Mark the centres of the four fixing holes, two of which are located in the front flange on the burner tray and two off are located through the rear support legs of the burner tray.

The preferred method of fixing for Zodiac Acclaim models which is suitable for almost all situations is the cable fixing method which is described in the following section in detail.

To fit using the preferred cable method proceed as follows-

- g) Mark out and drill 4 off No 14 (6mm) holes in the back face of the fire opening in the positions shown below in figure 5

Fig. 5

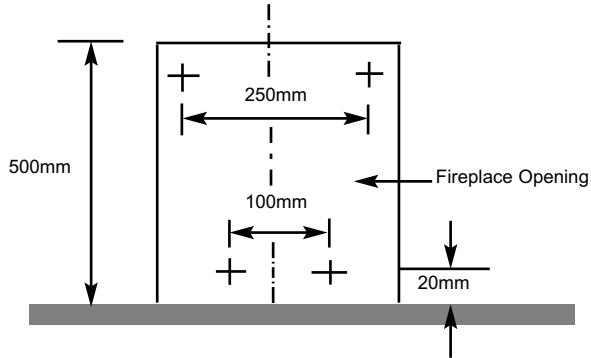

Fit the wallplugs provided and screw the fixing eyes securely into the rear of the fire opening.

- h) Uncoil the two fire fixing cables and thread one end of each of the cables through one of the two holes on each side of the flue outlet shroud.
- i) Position the fire carefully on the (protected) surface of the hearth and reach into the fire opening. Thread each of the cables vertically downwards through the pair of fixing eyes on the same side of the fire. Thread the free end of the cables through the corresponding circular hole on each side of the lower rear of the fire. Carefully slide the fire box back into the fire opening and pull both cables tight.
- j) Thread a tensioning screw over each of the cables and ensure that the tensioning nut is screwed fully up against the hexagon shoulder of the tensioning screw (this provides maximum travel for the tensioning nut).
- k) Fit a screwed nipple on to each of the cables and pull hand tight up against the tensioning screw, then secure each nipple with a flat bladed screwdriver. See figure 6 overpage.

Fig. 6

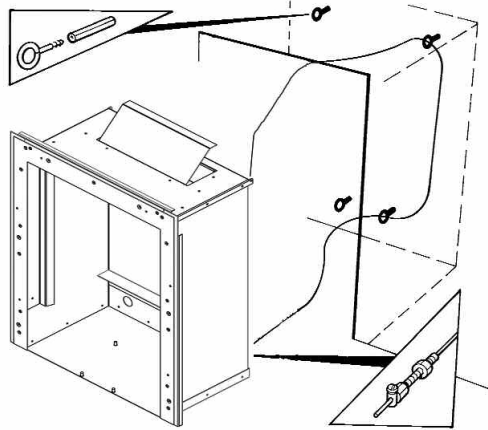

- m) Evenly tighten the tensioning nuts to tension both cables and pull the fire snugly against the wall. Do not overtighten, it is only necessary to pull the seal up against the sealing face of the wall, it does not need to be compressed. Check that there are no gaps behind the seal.
- n) With the fire securely in place, if a concealed gas connection has been made through either of the access holes in the sides of the fire, the holes should be closed around the pipe to prevent leakage of air through the gap around the pipe.
- o) Refit the burner. Fit the four retaining nuts and check that the burner is correctly locked into position.
- p) Refit the front burner heat shield to the control panel (2 screws)

q) **Making the gas connection**

The gas connection should be made to the appliance inlet elbow using rigid 8mm piping. **NOTE :- Failure to correctly purge the pipework will invalidate the guarantee.**

2.3 GAS TIGHTNESS AND INLET PRESSURE - MANUAL CONTROL MODELS.

- a) Remove the pressure test point screw from the inlet elbow and fit a manometer.
- b) Turn on the main gas supply and carry out a gas tightness test.
- c) Depress the control knob and turn anti-clockwise to the position marked ignition / low. Hold in the control knob for a few seconds to purge the pipe work then press the igniter button. The burner should light, continue to hold the control knob for a few seconds then turn to the full-on position.
- d) Check that the gas pressure for Natural Gas (G20) models is **20.0 mbar (+/- 1.0mbar) 8.0 in w.g.(+/- 0.4 in w.g.)** or for Propane Gas (G31) models **37.0 mbar (+/- 1.0mbar) 14.4 in w.g.(+/- 0.4 in w.g.)**
- e) Turn off the fire, remove the manometer and refit the pressure test point screw. Check the pressure test point screw for gas tightness with the appliance turned on using a suitable leak detection fluid or detector.

2.4 GAS TIGHTNESS AND INLET PRESSURE - REMOTE CONTROL OR ELECTRONIC FIRE CONTROL MODELS.

- a) Remove the pressure test point screw from the inlet elbow and fit a manometer.
- b) Turn on the main gas supply and carry out a gas tightness test.
- c) Light the fire, see page 21 / 22 for full details of the operating method for the fire.
- d) Check that the gas pressure is **20.0 mbar (+/- 1.0mbar) 8.0 in w.g.(+/- 0.4 in w.g.)**
- e) Turn off the fire, remove the manometer and refit the pressure test point screw. Check the pressure test point screw for gas tightness with the appliance turned on using a suitable leak detection fluid or detector.

SECTION 3 ASSEMBLING FUEL-BED AND COMMISSIONING

3.1 ASSEMBLING THE FUEL-BED

- a) Position the two halves of the ceramic front rail onto the support as shown below in Fig. 7

Fig. 7



- b) Place the fuelbed base centrally on to the fuelbed support and push fully backwards to the rear face of the cast iron back panel. **Make sure that the fuelbed base is located centrally on the burner tray.** See Fig. 8 below.

Fig. 8



- c) Fit three off medium and two off small square coals as shown in position on the front ceramic rails, see Fig. 9 below.

Fig. 9

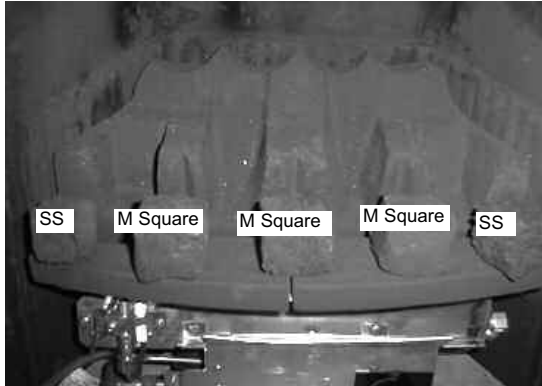

- d) Fit five off large coals into the recess's behind the front row of coals, as shown below in Fig. 10

Fig. 10

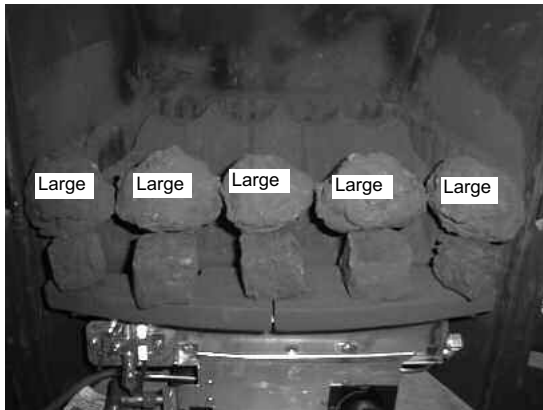

- e) Fit five small coals behind the second row of coals as shown below in Fig. 11

Fig. 11

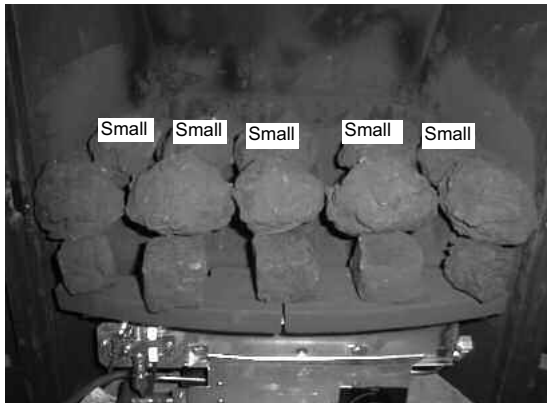

- f) Fit four small coals on the back row as shown below in Fig. 12

Fig. 12

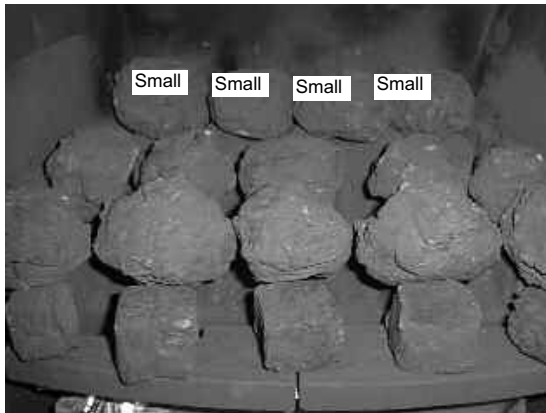

- g) The remaining two large and two small coals should be placed at each end of the third row of coals as shown overpage in Fig. 13

Fig. 13

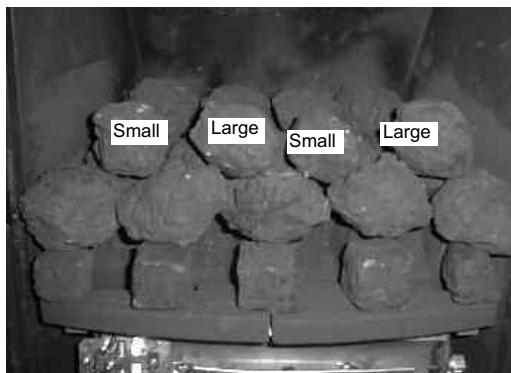

The exact position and fit of the coals may be finely adjusted to give the best appearance.

Warning : Use only the coal set supplied with the fire. When replacing the coals remove the old coals and discard them. Fit a complete set of coals of the correct type. Do not fit additional coals or any coals other than a genuine replacement set.

This appliance uses fuel effect pieces containing Refractory Ceramic Fibres (R.C.F.), which are man-made vitreous silicate fibres. Excessive exposure to these materials may cause temporary irritation to eyes, skin and respiratory tract. Consequently, it makes sense to take care when handling these articles to ensure that the release of dust is kept to a minimum. To ensure that the release of fibres from these R.C.F. articles is kept to a minimum, during installation & servicing we recommend that you use a HEPA filtered vacuum to remove any dust and soot accumulated in and around the fire, before and after working on the fire. When replacing these articles we recommend that the replaced items are not broken up, but are sealed within a heavy duty polythene bag, clearly labelled as “RCF waste”. This is not classified as “hazardous waste” and may be disposed of at a tipping site licensed for the disposal of industrial waste. Protective clothing is not required when handling these articles, but we do recommend you follow the normal hygiene rules of not smoking, eating or drinking in the work area, and always wash your hands before eating or drinking. This appliance does not contain any component manufactured from asbestos or asbestos related products.

3.2 FIXING THE INFRARED SENSOR IN POSITION (REMOTE CONTROL MODELS ONLY)

- a) Due to the different fascia's that can be supplied with these fires, the infrared sensor is supplied from the factory attached to a self adhesive pad. This pad can therefore be attached to the hearth in a position to suit the form of the fret assembly that is chosen with the product. Fig. 14 below shows the self adhesive pad and infrared eye attached to the flying lead, as supplied from the factory.

Fig. 14

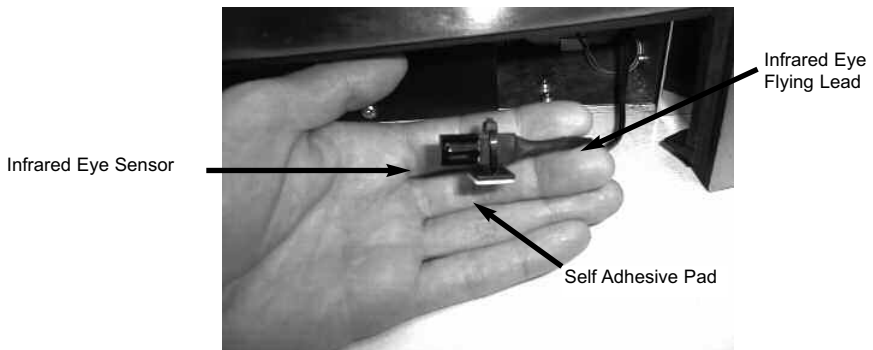

- b) Remove the backing paper from the self adhesive pad and position the infrared eye in the air channels in the ashpan cover, so that the infrared eye is flush with the front edge of the ashpan cover, as shown below in figure 15. Check the operation of the handset, as detailed in section 3.7 and adjust the position of the infrared eye if necessary.

Fig. 15



3.3 CONNECTING THE BATTERY PACK

- a) To prevent un-necessary battery drain, the battery pack that is used to provide the remote control function for this product is disconnected at the factory. Prior to attempting to light the product, can the installer please ensure that the battery pack is re-connected as shown in section b), c) & d) below.
- b) Locate the battery pack in the support cradle at the bottom R/H side of the firebox / burner assembly.
- c) The wire and connecting plug from the battery pack should then be connected into the supply wire running from the control board. See fig 16 below.

Fig. 16

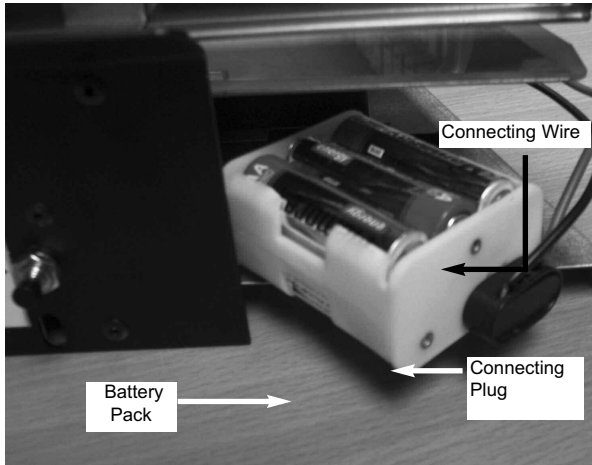

- d) Replace the battery pack into its mounting cradle below the burner.

3.4 FITTING THE TRIM (ZODIAC ACCLAIM MODELS ONLY)

- a) The trim is held in position on the fixing flange by magnets.

3.5 FITTING THE FENDER (ALL MODELS)

- a) The fender is placed up to the front of the ceramic front rail on all models. Position the ashpan under the fender and centralise.

3.6 LIGHTING THE APPLIANCE - MANUAL CONTROL MODELS

- a) Turn on the gas isolation tap.
- b) Depress the control knob and turn anti-clockwise to the position marked pilot. Hold in the control knob for a few seconds to purge the pipe work.
- c) Continue to hold-in the control knob and press the igniter button. If the burner does not light, continue to press the igniter button until ignition occurs. Continue to hold the control knob for 5-10 seconds to allow the thermocouple to heat up, if the pilot goes out when the control knob is released, repeat the lighting sequence.
- d) Turn the control knob in the anti-clockwise direction to the high position and the main burner will light.
- e) Turn the control knob clockwise to the low position and the gas input will be reduced to the minimum setting.
- f) Slightly depress the control knob and turn to the pilot position, the main burner will go out but the pilot will remain lit.
- g) Slightly depress the control knob and turn to the off position, the pilot will now be extinguished.

WARNING : If the fire goes out for any reason or is turned off and it is necessary to re-light the fire it is important to allow the fire to cool for 3 minutes before attempting to re-light it.

3.7 LIGHTING THE APPLIANCE - REMOTE CONTROL MODELS

- a) The Remote control handset generates an infrared signal, which will be received by the sensor situated at the front right of your fire, behind the ashpan cover. This infrared signal requires direct line of sight from the handset to the sensor on the fire to ensure good operation.
- b) To light the appliance using the handset, point the handset at the fire and press the 2 left hand buttons together. The fire will emit a “beep” sound, the buttons can now be released. After a few seconds an audible clicking can be heard and then the fire will light the pilot and then light the main burner. The ignition cycle will take approximately 20 seconds.
- c) To reduce the level of heat input on the fire, point the handset at the fire and press the small flame button. (An audible beep will be heard)
- d) To increase the level of heat input on the fire, point the handset at the fire and press the large flame button. (An audible beep will be heard)
- e) To leave the fire in the standby mode (pilot only running) press the small round button on the handset.
- f) To switch the appliance off completely, press the large round button on the handset, the fire will then switch off.

Fig. 17

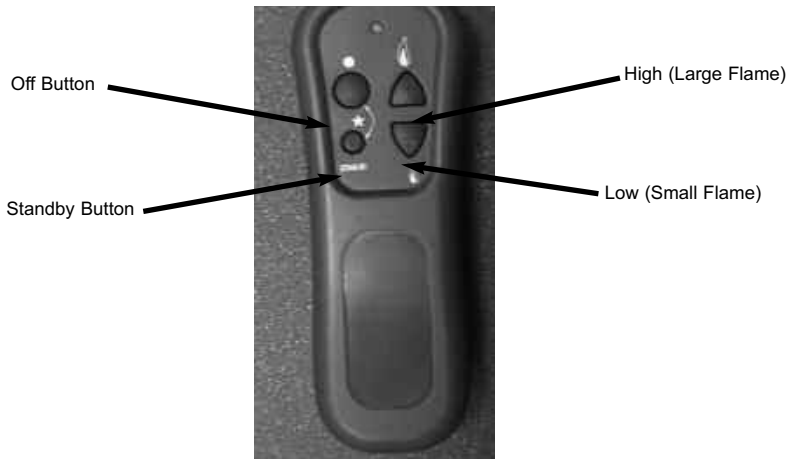

WARNING : If the fire goes out for any reason or is turned off and it is necessary to re-light the fire it is important to allow the fire to cool for 3 minutes before attempting to re-light it.

3.8 LIGHTING THE APPLIANCE - ELECTRONIC FIRE CONTROL MODELS.

- a) To light the fire using the electronic fire control, press the ignition button as indicated below in figure 18. The fire will emit a “beep” sound, the buttons can now be released. After a few seconds an audible clicking can be heard and then the fire will light the pilot and then light the main burner. The ignition cycle will take approximately 20 seconds.
- b) To reduce the level of heat input on the fire, press the small flame button on the trim switch. (An audible beep will be heard)
- c) To increase the level of heat input on the fire, press the large flame button on the trim switch. (An audible beep will be heard)
- d) To leave the fire in the standby mode (pilot only running) press the small round button on the trim switch. (An audible beep will be heard)
- e) To switch the appliance off completely, press the Ignition / Off button on the trim switch, the fire will then switch off. (An audible beep will be heard)

Fig. 18

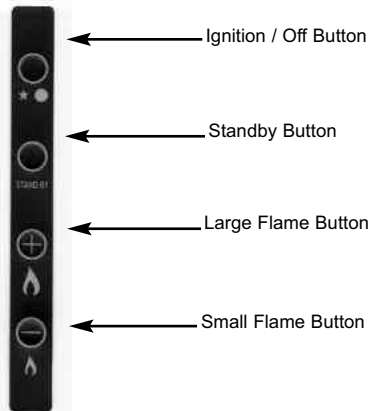

WHEN TURNING THE FIRE “OFF” PLEASE ENSURE THAT THE PILOT FLAME IS EXTINGUISHED. DO NOT LEAVE THE PILOT FLAME ONLY LIT.

WARNING : If the fire goes out for any reason or is turned off and it is necessary to re-light the fire it is important to allow the fire to cool for 3 minutes before attempting to re-light it.

3.9 CHECKING FOR CLEARANCE OF COMBUSTION PRODUCTS

- a) Close all doors and windows in the room.
- b) Light the fire and allow to run for approximately 5 minutes on high position.
- c) After approximately 5 minutes hold a smoke match just inside and below the centre of the lower front edge of the top of the fireplace opening (on Acclaim models only). For Zodiac Acclaim models hold a smoke match below the centre of the canopy on the firebox. (It is recommended that a suitable smoke match holder is used when checking for clearance of combustion products). All smoke generated should be drawn back into the flue. If slight spillage occurs or if in doubt, repeat the test after a further 5-10 minutes.
- d) If spillage persists, the flue is not functioning correctly and a fault exists. If, after investigation the fault cannot be traced and rectified, the fire must be disconnected from the gas supply and expert advice obtained.
- e) If there is an extractor fan fitted anywhere in the vicinity of the appliance, or in adjacent rooms the spillage test should be repeated with the fan running on maximum and all interconnecting doors open.
- f) After ensuring that the fire is safe to use it should be left on high position to fully warm up. During this time a slight odour may be noticed, this is due to the "newness" of the fire and will soon disappear. At this stage any minor adjustments to the coals should be made using suitable long handled tongs and taking care not to damage the coals.

Finally, hand the Installation and Maintenance Instructions and the Users Instructions over to the customer and explain the operation of the fire.

SECTION 4 MAINTENANCE

Servicing Notes

Servicing should be carried out annually by a competent person such as a GAS SAFE registered engineer. **This is a condition of the Verine guarantee schemes.**

The service should include visually checking the chimney and fire opening for accumulations of debris and a smoke test to check for a positive up-draught in the chimney. The pilot must also be changed as a condition of the guarantee.

The condition of the coals should be checked and **if necessary the whole set should be replaced with a genuine replacement set.**

The burner assembly is designed to be removed as a complete unit for ease of access. **After any servicing work a gas tightness check must always be carried out. All sections apply for coal fuelbed model variants.**

For Diagrams refer to Section 2

4.1 Removing the burner assembly from the fire (MC models)

4.1.1 Prepare work area (lay down dust sheets etc.)

4.1.2 Remove the fender/ ash pan cover and put them in a safe location. Remove the loose coals from the fuel bed. Remove the fuelbed matrix & ceramic front rails.

4.1.3 Isolate the gas supply and remove the inlet pipe from the appliance inlet elbow. Unscrew and remove the four screws (Acclaim tray models) or four nuts which retain the burner at the base (Zodiac Acclaim models). Remove the burner tray assembly from the fireplace / firebox.

4.1.4 To refit the burner assembly. Place the burner into the opening or firebox and secure the burner at the base of the control panel with four screws or nuts as applicable. Refit the gas supply pipe and carry out a gas tightness test. The ash pan cover and front bars can now be re-positioned.

4.2 Removing the Piezo Igniter (MC models)

4.2.1 Remove the burner assembly as in section 4.1

4.2.2 Disconnect the ignition lead from the piezo and unscrew the retaining nut on the rear of the control panel. Withdraw the piezo from the front of the control panel. Re-assemble in reverse order and carry out a gas tightness test. Ensure the heatshield is re-fitted.

4.3 Removing the Control Tap from the fire (MC models)

- 4.3.1 Remove the burner assembly as in section 4.1.
- 4.3.2 Pull the control knob off the control tap spindle.
- 4.3.3 Loosen and remove the two gas pipe retaining nuts from the control tap and release the ends of the gas pipes from the control tap body. Remove the screw in thermocouple from the end of the control tap.
- 4.3.4 Unscrew the control tap locknut from the front of the control panel and remove the control tap.
- 4.3.5 To refit a control tap, reassemble in reverse order noting that the control tap locates with a flat in the control panel. Carry out a gas tightness test after re-assembly.

4.4 Removing the Oxy-Pilot Assembly (MC Models)

Note : Because this appliance is fitted with an atmosphere sensing 'Oxy-Pilot' it is not possible to replace the thermocouple separately, because the thermocouple position is factory set to a tight tolerance. Any replacement of parts on the pilot requires a complete new pilot assembly.

- 4.4.1 Remove the burner assembly as in section 4.1
- 4.4.2 Remove the burner heat shield which is held in position by 2 screws.
- 4.4.3 Unscrew and remove the thermocouple retaining nut from the end of the control tap and disconnect the ignition lead from the pilot electrode.
- 4.4.4 Unscrew and remove the two pozi-driv screws which secure the pilot assembly to the burner. Remove the pilot.
- 4.4.5 Re-assemble in reverse order and carry out a gas tightness test.

4.5 Removing the burner assembly from the fire (RC & EFC models).

- 4.5.1 Prepare work area (lay down dust sheets etc.)
- 4.5.2 Lift the fender and ash pan cover of the way and put them in a safe location. Remove the loose coals from the fuel bed and front ceramic rail. Remove the front ceramic from the rail. Unscrew the two pozi-driv fixing screws which secure the burner heat shield and remove it from the fire.

- 4.5.3 Isolate the gas supply and remove the inlet pipe from the appliance inlet elbow. Unscrew and remove the two screws which retain the burner. Remove the HT lead from the Pilot electrode and remove the burner assembly from the fire, ensuring not to pull too tightly on the PCB wiring. Cut the cable tie from the remote infrared eye self adhesive pad, which will be situated on the hearth panel, flush with the front edge of the ashpan cover.
- 4.5.4 To refit the burner assembly. Ensure wiring is fitted correctly to the PCB assembly. Push the base of the control panel fully into the fire and secure with the two screws. Refit the gas supply pipe and carry out a gas tightness test. Refit the burner heat shield then refit the coals / referring to section 3 for the correct coal layout. The infrared eye must be cable tied back to the self adhesive pad which will be situated on the hearth panel. The fender and ash pan cover or can now be re-positioned.

4.6 Removing the Valve Assembly (RC & EFC models).

- 4.6.1 Remove the burner assembly as in section 4.10
- 4.6.2 Remove the thermocouple retaining nut from the valve. remove the main pipe, inlet pipe and pilot pipe from the valve.
- 4.6.3 Remove the valve retaining screws and remove. Re-assemble in reverse order and carry out a gas tightness test. Re-fit coals as shown in section 3. The fender and ash pan cover can now be re-positioned.

4.7 Removing the Pilot Assembly (RC & EFC models).

Note : Because this appliance is fitted with an atmosphere sensing 'Oxy-Pilot' it is not possible to replace the thermocouple separately, because the thermocouple position is factory set to a tight tolerance. Any replacement of parts on the pilot requires a complete new pilot assembly.

- 4.7.1 Remove the burner assembly as in section 4.1.
- 4.7.2 Unscrew the thermocouple retaining nut from the solenoid.
- 4.7.3 Loosen the pilot nut and remove two screw retaining the pilot assembly.
- 4.7.4 Re-assemble in reverse order and carry out a gas tightness test. Re-fit coals as shown in section 3. The fender and ash pan cover can now be re-positioned.

4.8 Replacing the Batteries (RC & EFC models).

- 4.8.1 Remove the fender and ashpan assembly The battery holder is located on the right hand side of the appliance .
 - 4.8.2 Remove the battery pack with care and then disconnect the battery lead at the white rectangular plug and socket.
 - 4.8.3 Replace in reverse order and check correct operation of the appliance.
- NB The handset uses one LR61 (9v) and should be replaced by removing the cover on the rear of the handset.

ENSURE THE BATTERIES ARE CONNECTED TO THE CORRECT POLARITY POSITIVE (+) NEGATIVE (-)

4.9 Removing the Trim Switch (EFC models).

- 4.9.1 Remove ash-pan, fret assembly / trim or fascia from the front of the fire.
- 4.9.2 Isolate the gas supply, disconnect the gas control valve to bulkhead pipe and pilot / thermcouple connections to the pilot. Remove the fire from the opening.
- 4.9.3 Pull controls sub assembly forward, disconnect the trim switch lead from the control board, remove the EFC mounting frame from the fire.
- 4.9.4 Remove the EFC trim switch from mounting frame via the self adhesive pad, disconnect the wiring loom.
- 4.9.5 Replace in reverse order and carry out a gas tightness test.

PARTS SHORTLIST

Replacement of any other parts must be carried out by a competent person such as a GAS SAFE registered gas installer. The part numbers of the main replaceable parts are as follows, these are available from BFM Europe, see rear page for contact details

Coal Pack	B-87350	Coal Fuelbed Matrix	B-87340
L/H Ceramic Front Rail	B-87300	R/H Ceramic Front Rail	B-87310
Gas Valve	B-102880	RC / EFC gas control valve	B-106790
RC / EFC control board	B-106800	RC / EFC battery cable	B-106810
RC / EFC battery holder	B-106820	Piezo Igniter	B-1320
Ignition wire MC models	B-39030		
Ignition wire RC / EFC models	B-63650		
EFC control switch	B-152610		
EFC control switch lead	B-152650		

SECTION FIVE - USER INSTRUCTIONS

5.1 About your Verine Acclaim Inset Tray / Zodiac Acclaim Inset Tray & Hotbox

The Verine Zodiac Acclaim Inset Tray & Zodiac Acclaim Inset Tray & Hotbox incorporates a unique and highly developed fuel bed which gives the realism of a loose coal layout combined with realistic flames and glow. The use of durable ceramic material in the construction of the fuel-bed components ensures long and trouble free operation.

When first using the new fire a slight smell may be noticed. This is due to starch used in the manufacture of the soft ceramic coals, it is non-toxic and will soon disappear.

Please take the time to fully read these instructions as you will then be able to obtain the most effective and safe operation of your fire.

IMPORTANT SAFETY INFORMATION

WARNING

This appliance has a naked flame and as with all heating appliances a fireguard should be used for the protection of children, the elderly and infirm. Fireguards should conform to B.S. 8423 : 2002 (Fireguards for use with gas heating appliances).

It is important that this appliance is serviced at least once a year by a GAS SAFE registered gas installer and that during the service the fire is removed from the fire opening and the chimney or flue visually checked for fallen debris or blockages which must be removed. The pilot must also be changed as a condition of the guarantee. The chimney should also be checked to ensure clearance of flue products. **These are conditions of the manufacturers guarantee. After installation or during servicing a spillage test must always be carried out.**

Rubbish of any type must NEVER be thrown onto the fuel-bed, this could affect safe operation and damage the fire.

Any debris or deposits should be removed from the fuel-bed from time to time. This may be carried out by referring to the cleaning section as described later in this book.

Only the correct number and type of coals must be used and only complete and genuine replacement sets must be sourced from BFM Europe Ltd. (see rear cover of this book for contact details).

The appliance must only be used with the coal set supplied and must not be used with other coals.

Always keep furniture and combustible materials well clear of the fire and never dry clothing or items either on or near to the fire. Never use aerosols or flammable cleaning products near to the fire when it is in use.

The ceramic fuel-bed remains hot for a considerable period after use and sufficient time should be allowed for the fire to cool before cleaning etc. The fire must only be operated with the cast surround supplied with the fire.

5.2 OPERATING THE FIRE - MANUAL CONTROL MODELS.

The controls are located behind the ashpan cover which is situated below the fender. The controls, comprise a control valve to adjust the gas flow and a push button piezo igniter. To light the fire proceed as follows:-

- a) Depress the control knob and turn anti-clockwise to the position marked pilot. Hold in the control knob for a few seconds to allow the gas to reach the pilot.
- b) Continue to hold-in the control knob and press the igniter button. If the pilot does not light, continue to press the igniter button until ignition occurs. When the pilot has lit, continue to hold the control knob in for 5-10 seconds to allow the thermocouple to heat up, if the pilot goes out when the control knob is released, repeat the lighting sequence.

In the unlikely event of a failure of the igniter, the fire can be lit as follows :-
Depress the control knob and turn anti-clockwise to the position marked pilot. Hold in the control knob for a few seconds to allow the gas to reach the pilot. Insert the tip of a lit taper in behind the front ceramic coals on the left hand side. This will light the pilot flame. When the pilot has lit, continue to hold the control knob in for 5-10 seconds to allow the thermocouple to heat up, if the pilot goes out when the control knob is released, repeat the lighting sequence.

- c) After lighting, turn the control knob in the anti-clockwise direction to the high position and the main burner will light. It is recommended that for most efficient performance the fire is allowed to warm up for a few minutes with the gas control on maximum.
- d) The gas control can be turned clockwise from the maximum position to give the desired heat output.

WARNING : If the fire goes out for any reason or is turned off and it is necessary to re-light the fire it is important to allow the fire to cool for 3 minutes before attempting to re-light it.

5.3 OPERATING THE FIRE - REMOTE CONTROL MODELS.

The controls comprise a remote control handset to ignite the fire and adjust the gas flow. The Remote control handset generates an infrared signal, which will be received by the sensor situated at the front of your fire, below the ashpan cover. This infrared signal requires direct line of sight from the handset to the sensor on the fire to ensure good operation. To light the fire proceed as follows:-

- a) To light the appliance using the handset, point the handset at the fire and press the 2 left hand buttons together. The fire will emit a “beep” sound, the buttons can now be released. After a few seconds an audible clicking can be heard and then the fire will light the pilot and then light the main burner. The ignition cycle will take approximately 20 seconds. It is recommended that for the most efficient performance the fire is allowed to warm up for a few minutes with the input set to high.
- b) To reduce the level of heat input on the fire, point the handset at the fire and press the small flame button once. (An audible beep will be heard) and the heat input level will reduce to the low setting (4.2kW). Press and continually hold the small flame button and the fire will reduce incrementally to the low setting (4.2kW)
- c) To increase the level of heat input on the fire, point the handset at the fire and press the large flame button. (An audible beep will be heard) and the heat input level will increase to the high setting (6.9kW) Press and continually hold the small flame button and the fire will reduce incrementally to the high setting (6.9kW)
- d) To leave the fire in the standby mode (pilot only running) press the small round button on the handset. **The fire should not be left in the standby mode when unattended.**
- e) To switch the appliance off completely, press the large round button on the handset, the fire will then switch off. See figure 1 overpage for image of the handset.

Fig. 1

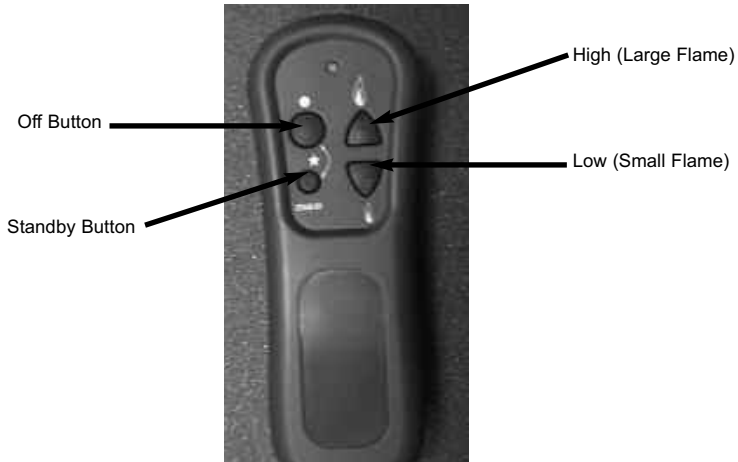

WARNING : If the fire goes out for any reason or is turned off and it is necessary to re-light the fire it is important to allow the fire to cool for 3 minutes before attempting to re-light it.

5.4 LIGHTING THE APPLIANCE - ELECTRONIC FIRE CONTROL MODELS.

- a) The controls comprise an electronic fire control (EFC) trim switch to ignite the fire and adjust the gas flow. The electronic fire control trim switch is located at the top right hand side of the fire.
To light the fire using the electronic fire control (trim switch), press the ignition button as indicated overpage in figure 2. The fire will emit a “beep” sound, the button can now be released. After a few seconds an audible clicking can be heard and then the fire will light the pilot and then light the main burner. The ignition cycle will take approximately 20 seconds. It is recommended that for the most efficient performance the fire is allowed to warm up for a few minutes with the input set to high.
- b) To reduce the level of heat input on the fire, press the small flame button on the trim switch. (An audible beep will be heard)
- c) To increase the level of heat input on the fire, press the large flame button on the trim switch. (An audible beep will be heard)
- d) To leave the fire in the standby mode (pilot only running) press the small round button on the trim switch. (An audible beep will be heard).**The fire should not be left in the standby mode when unattended.**

- e) To switch the appliance off completely, press the Ignition / Off button on the trim switch, the fire will then switch off. (An audible beep will be heard)

Fig. 2

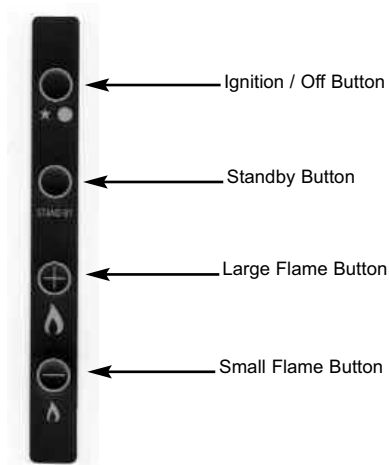

WARNING : If the fire goes out for any reason or is turned off and it is necessary to re-light the fire it is important to allow the fire to cool for 3 minutes before attempting to re-light it.

5.5 TURNING THE PRODUCT OFF IN THE UNLIKELY EVENT OF A REMOTE HANDSET OR EFC TRIM SWITCH MALFUNCTION.

- a) In the unlikely event of the remote control handset or EFC trim switch malfunctioning (or if lost or broken) after the appliance has been turned on, the fire can be turned off via the emergency shut off switch on the control panel.
- b) To turn the product off, firstly remove the ashpan from the fire.
- c) Press and hold the emergency shut off switch until the fire shuts down. The process may take up to sixty seconds to complete. (see figure 3 below).
- d) When the fire has shut down, release the emergency shut off switch.
- e) The appliance will now remain in the “off” position until activated by the remote handset / EFC trim switch (whichever is applicable).

Fig. 3



5.6 REPLACING THE BATTERIES - REMOTE CONTROL / ELECTRONIC FIRE CONTROL MODELS

- a) Remove the ashpan cover
- b) The battery pack is located on the right hand side side of the burner unit at the bottom.
- c) Carefully remove the pack and remove the batteries.
- d) Replace in the reverse order using 6 off 1.5V AA Alkaline Battery. **It is important that only an alkaline battery is used, otherwise premature battery failure and leakage may result.**

SPILLAGE MONITORING SYSTEM

This appliance is fitted with a spillage monitoring system which shuts down the fire if the evacuation of combustion products from the fire is affected by a partially or fully blocked flue. If this system operates the fire will go out. If this occurs, leave the fire for at least three minutes then follow the lighting procedure as described in the previous section. **In the event of repeated operation a GAS SAFE registered gas installer must be called to investigate and rectify the cause.**

5.7 Cleaning - WARNING

Before attempting any cleaning operation ensure that the fire has been allowed to fully cool. Black painted metal parts should be gently cleaned with a damp cloth.

Cleaning the Fuelbed

We do not recommend cleaning of the coals or fuelbed components as these are fragile and damage may result. **None of these parts must be washed or exposed to any cleaning agents or water.** Any damaged parts must be replaced by contacting BFM Europe Ltd. (See rear cover of this book for contact details). The coals must only be replaced with a complete and genuine replacement set and the fire must never be run with the wrong number or damaged coals. The fuel-bed must be carefully re-assembled as stated in section 5.8 overpage.

5.8 Replacing the Fuel-bed & Ceramics

- a) Position the two halves of the ceramic front rail onto the support as shown below in Fig. 4

Fig. 4



- b) Place the fuelbed base centrally on to the fuelbed support and push fully backwards to the rear face of the cast iron back panel. **Make sure that the fuelbed base is located centrally on the burner tray.** See Fig. 5 below.

Fig. 5



- c) Fit three off medium and two off small square coals as shown in position on the front ceramic rails, see Fig. 6 below.

Fig. 6

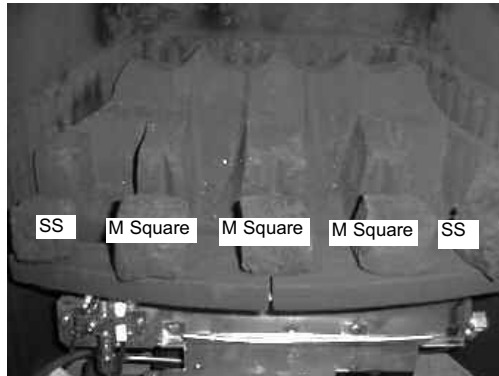

- d) Fit five off large coals into the recess's behind the front row of coals, as shown below in Fig. 7

Fig. 7

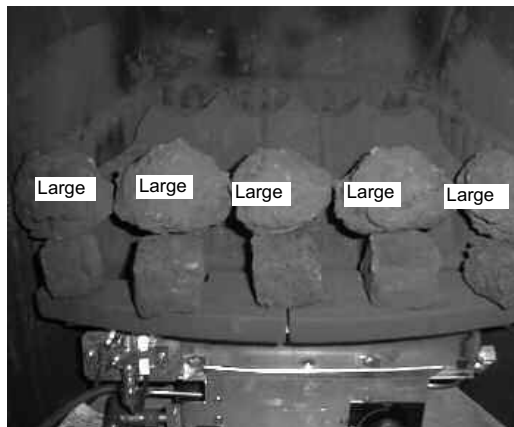

- e) Fit five small coals behind the second row of coals as shown below in Fig. 8

Fig. 8

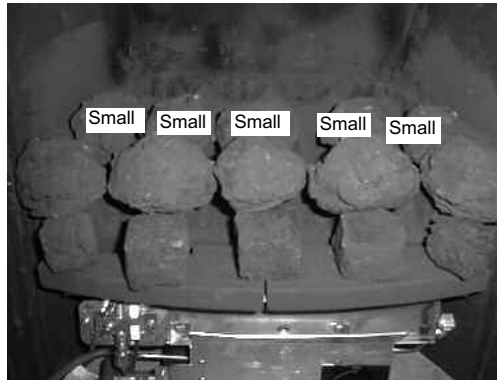

- f) Fit four small coals on the back row as shown below in Fig. 9

Fig. 9

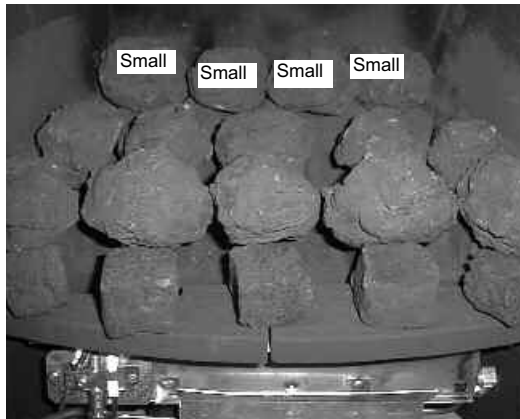

- g) The remaining two large and two small coals should be placed at each end of the third row of coals as shown overpage in Fig. 10

Fig. 10

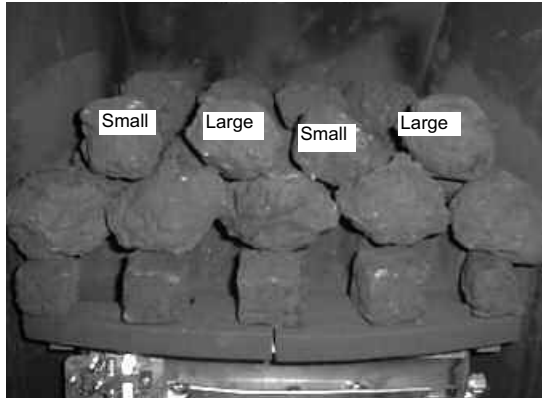

The exact position and fit of the coals may be finely adjusted to give the best appearance.

Warning : Use only the coal set supplied with the fire. When replacing the coals remove the old coals and discard them. Fit a complete set of coals of the correct type. Do not fit additional coals or any coals other than a genuine replacement set.

This appliance uses fuel effect pieces containing Refractory Ceramic Fibres (R.C.F.), which are man-made vitreous silicate fibres. Excessive exposure to these materials may cause temporary irritation to eyes, skin and respiratory tract. Consequently, it makes sense to take care when handling these articles to ensure that the release of dust is kept to a minimum. To ensure that the release of fibres from these R.C.F. articles is kept to a minimum, during installation & servicing we recommend that you use a HEPA filtered vacuum to remove any dust and soot accumulated in and around the fire, before and after working on the fire. When replacing these articles we recommend that the replaced items are not broken up, but are sealed within a heavy duty poly-thene bag, clearly labelled as "RCF waste". This is not classified as "hazardous waste" and may be disposed of at a tipping site licensed for the disposal of industrial waste. Protective clothing is not required when handling these articles, but we do recommend you follow the normal hygiene rules of not smoking, eating or drinking in the work area, and always wash your hands before eating or drinking. This appliance does not contain any component manufactured from asbestos or asbestos related products.

USER REPLACEABLE PARTS

The only user replaceable parts on this fire are the fuelbed components and coals which may be replaced as described in the above section. Replacement of any other parts must be carried out by a competent person such as a GAS SAFE registered gas installer. The part numbers of the user replaceable parts are as follows, these are available from BFM Europe Ltd. (See rear cover of this book for contact details).

Coal Pack
L/H Ceramic Front Rail

B-87350
B-87300

Coal Fuelbed Matrix
R/H Ceramic Front Rail

B-87340
B-87310

Due to our policy of continual improvement and development the exact accuracy of descriptions and illustrations cannot be guaranteed.

Part No. B-1004283
Issue 1

V E R I N E
F I R E S T O I N S P I R E

BFM Europe Ltd
Trentham Lakes
Stoke-on-Trent
Staffordshire
ST4 4TJ

www.bfm-europe.com

Telephone - General Enquiries : (01782) 339000
Telephone - Service : (01782) 339008